

Glass Magnetic Nailable

Writing Board

Installation illustrate

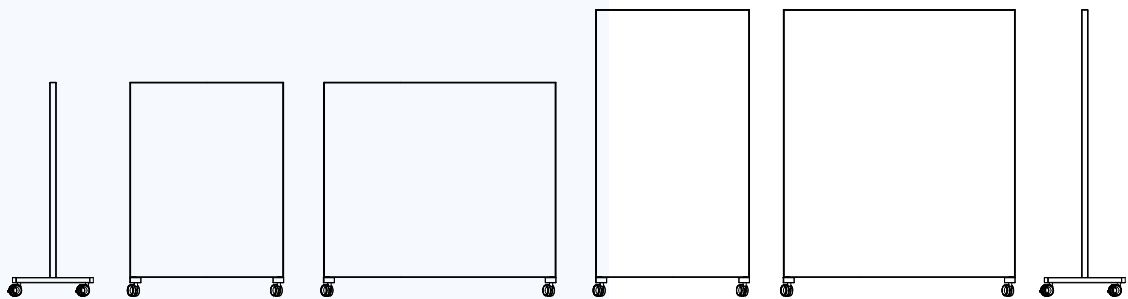

Web : <https://www.mwworkstation.com/>

Tel : +86 13695211636

Mail : robbor@mwworkstation.com



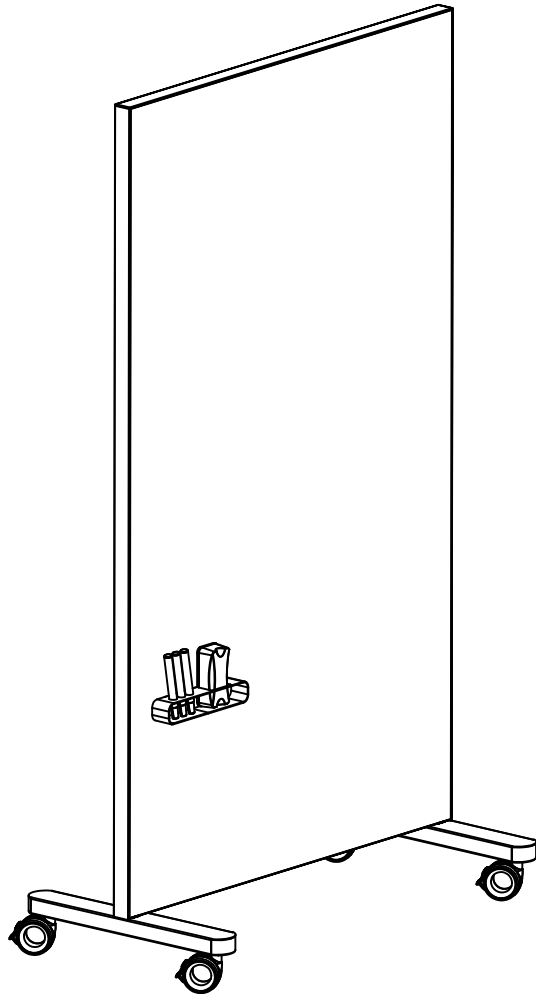





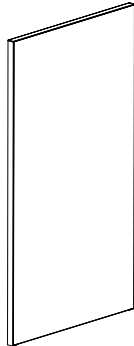

Thanks for choosing K-Board. Please read this manual carefully before installing it.



Warning

- Please follow the manual and notes to install, Improper installation can result in falling, injury, etc.
- Please confirm the state of glass board before installing. If it is broken, please do not touch it.
- Please don't disassemble or modify the glass board by yourself.
- Please don't replace the screws and accessories of the K-Board.

Product list

Glass board	Steel leg	Castor	Pen	Two-way tape	13mm allen key
1 PCS	2 PCS	4 PCS	12 PCS	3 PCS	1 PCS
					
	Pen Holder	Eraser	Magnet	Screw	14mm allen key
	1 PCS	1 PCS	10 PCS	4 PCS	1 PCS
					

1. The castors fixed on the steel leg.

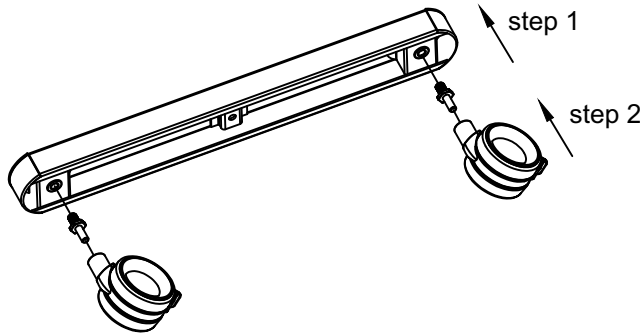

● Pull out the screw of castor

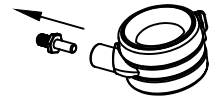

2. Steel legs fixed on the glass board.

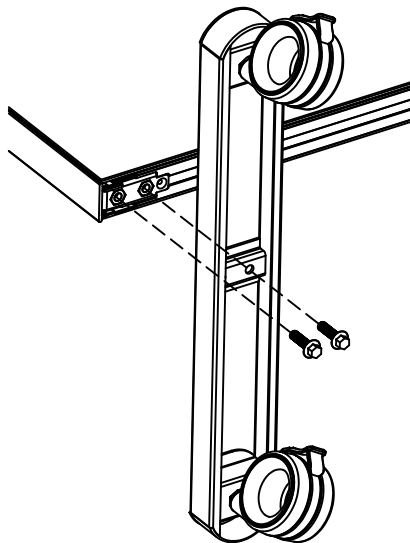

● Tighten the screws

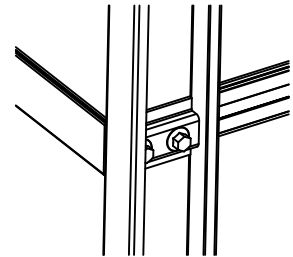

2. Use two-way tape fixed the pen holder on the glass board

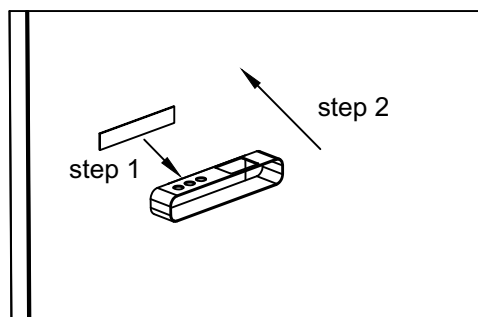

● After sticking the pen holder on the board, please press the pen holder to make it stick firmly.

1. Eraser

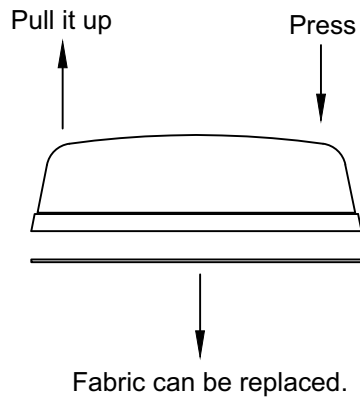

- 4pcs spared fabric in eraser

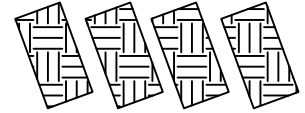

2. Ink pen

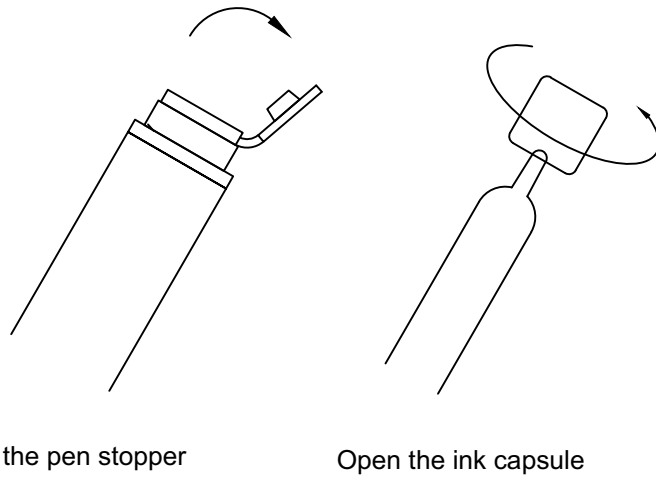

- Shake the ink capsule before opening it

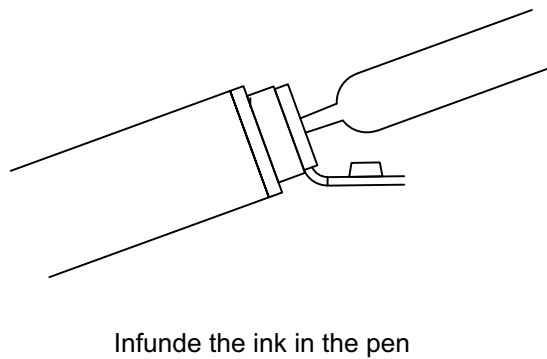
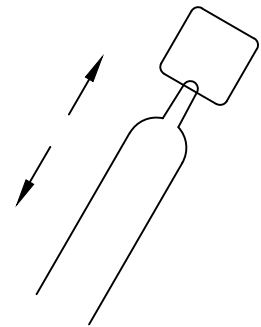

- Shake the pen before use.

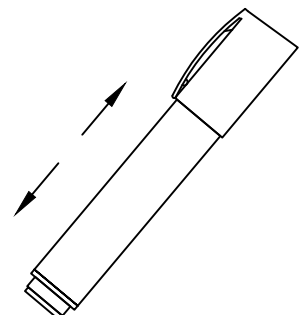

M & W

Web: mwworkstation.com

Mail: robbor@mwworkstation.com

Tel: +86 13695211636

WhatsApp: + 86 13695211636

Add: NO.3 Xingye North Road Dawotang Industrial
District Shishan Nanhai Foshan City Guangdong
P.R China



WhatsApp



Facebook



Instagram



Twitter



Pinterest



Linkein



YouTube